

Gabellichtschranken *fork light barriers* OPTOR® G30

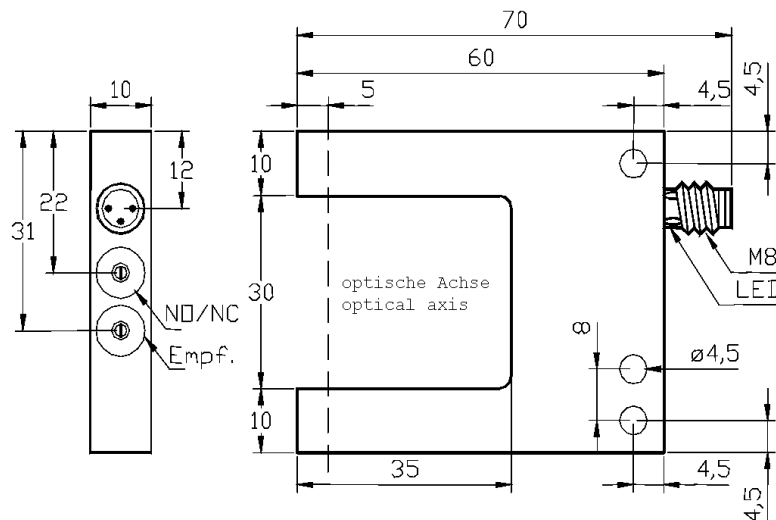

Standard *standard*

Gabelweite <i>fork opening</i>	30 mm
Anschluss <i>connection</i>	Stecker M8 <i>plug M8</i>
Empfindlichkeit <i>sensitivity</i>	einstellbar <i>adjustable</i>



Gabellichtschranken
fork light barriers

Betriebsspannung <i>service voltage</i>	10-35 VDC		
Eigenstromaufnahme <i>internal power consumpt.</i>	< 35 mA		
Spannungsabfall <i>voltage drop</i>	< 2,5 V		
Schalthyserese <i>switching hysteresis</i>	< 0,2 mm		
Reproduzierbarkeit <i>reproducibility</i>	< 0,01 mm		
Temperaturdrift <i>temperature drift</i>	< 10 %		
Umgebungstemperatur <i>ambient temperature</i>	- 10°C ... + 60°C		
Schutzart <i>protection class</i>	IP 67		
Sendelicht <i>emitted light</i>	infrarot / getaktet <i>infrared / clocked</i>	rot / getaktet <i>red / clocked</i>	infrarot / getaktet <i>infrared / clocked</i>
Gehäusematerial <i>casing material</i>	Alu / schwarz eloxiert <i>aluminium / black anodized</i>		
Isolationsspannung <i>insulation voltage endurance</i>	500 V		
Fremdlichtfestigkeit <i>ambient light immunity</i>	50 klx		
Auflösung <i>resolution</i>	0,4 mm	0,4 mm	1,5 mm
max. Laststrom <i>max. load current</i>	200 mA / kurzschlußfest <i>short-circuit-proof</i>		
Schaltfrequenz <i>max. operating frequency</i>	5 kHz		

Schema <i>diagramm</i>	Ausgang <i>output</i>	Infrarot <i>infrared</i>	Rotlicht <i>red light</i>	Schmutzunempfindlich <i>dirt non sensitive</i>
3	PNP-NO/NC	EGMD0307I	EGMD0307R	EGMD0307L
1	PNP-NO	EGMD0304I	EGMD0304R	EGMD0304L
2	PNP-NC	EGMD0305I	EGMD0305R	EGMD0305L
6	NPN-NO/NC	EGMD0306I	EGMD0306R	EGMD0306L
4	NPN-NO	EGMD0302I	EGMD0302R	EGMD0302L
5	NPN-NC	EGMD0303I	EGMD0303R	EGMD0303L



Schema 1 *diagramm 1*

PNP Schließer (NO)
PNP closer (NO)

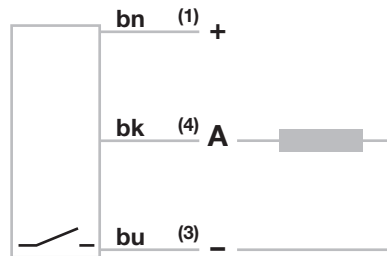

Schema 2 *diagramm 2*

PNP Öffner (NC)
PNP opener (NC)

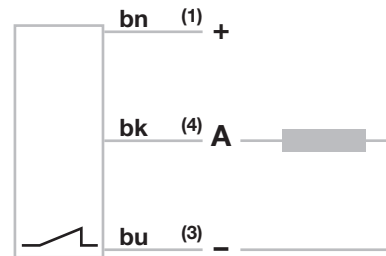

Schema 3 *diagramm 3*

PNP Schließer/Öffner (NO/NC)
PNP closer/opener (NO/NC)

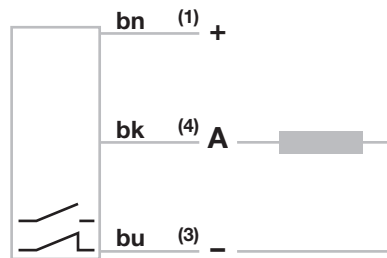

Schema 4 *diagramm 4*

NPN Schließer (NO)
NPN closer (NO)

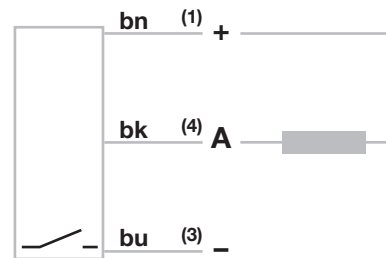

Schema 5 *diagramm 5*

NPN Öffner (NC)
NPN opener (NC)

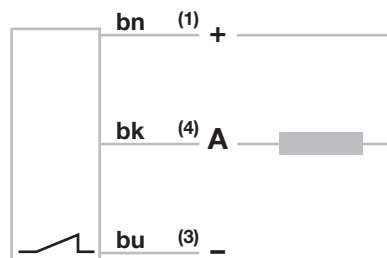

Schema 6 *diagramm 6*

NPN Schließer/Öffner (NO/NC)
NPN closer/opener (NO/NC)

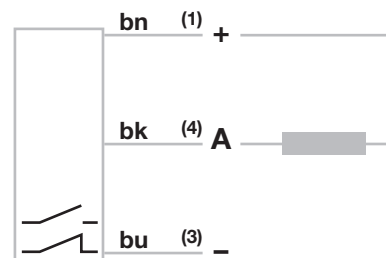

Schema 8 *diagramm 8*