

Standard *standard*

Gabelweite <i>fork opening</i>	2 mm
Anschluss <i>connection</i>	Stecker M8 <i>plug M8</i>
Empfindlichkeit <i>sensitivity</i>	einstellbar <i>adjustable</i>

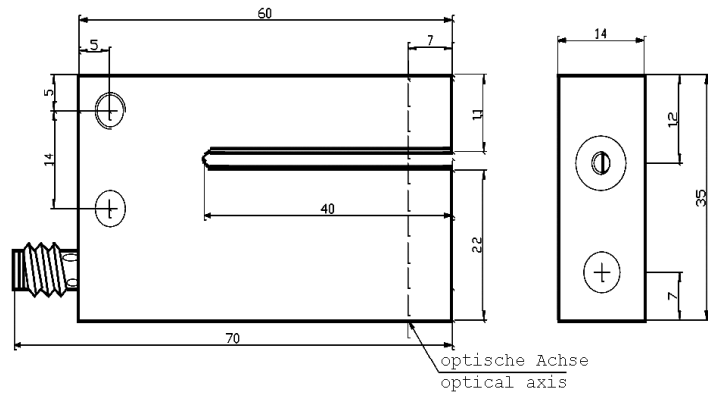

Gabellichtschranken
fork light barriers

Betriebsspannung <i>service voltage</i>	10-35 VDC	
Eigenstromaufnahme <i>internal power consumption</i>	< 35 mA	
Spannungsabfall <i>voltage drop</i>	< 2,5 V	
Schalthysterese <i>switching hysteresis</i>	< 0,2 mm	
Reproduzierbarkeit <i>reproducibility</i>	< 0,01 mm	
Temperaturdrift <i>temperature drift</i>	< 10 %	
Umgebungstemperatur <i>ambient temperature</i>	- 10°C ... + 60°C	
Schutzart <i>protection class</i>	IP 67	
Sendelicht <i>emitted light</i>	röt / getaktet <i>red / clocked</i>	infrarot / getaktet <i>infrared / clocked</i>
Gehäusematerial <i>casing material</i>	Alu / schwarz eloxiert <i>aluminium / black anodized</i>	
Isolationsspannung <i>insulation voltage end</i>	500 V	
Fremdlichtfestigkeit <i>ambient light immunity</i>	50 klx	
Auflösung <i>resolution</i>	0,4 mm	
max. Laststrom <i>max. load current</i>	200 mA / kurzschlußfest <i>short-circuit-proof</i>	
Schaltfrequenz <i>max. operating frequency</i>	2,5 kHz	

Schema <i>diagramm</i>	Ausgang <i>output</i>		
3	PNP-NO/NC	EGMD0024R	EGMD0024I
1	PNP-NO	EGMD0025R	EGMD0025I
2	PNP-NC	EGMD0027R	EGMD0027I
6	NPN-NO/NC	EGMD0022R	EGMD0022I
4	NPN-NO	EGMD0023R	EGMD0023I
5	NPN-NC	EGMD0026R	EGMD0026I



Schema 1 *diagramm 1*

PNP Schließer (NO)
PNP closer (NO)

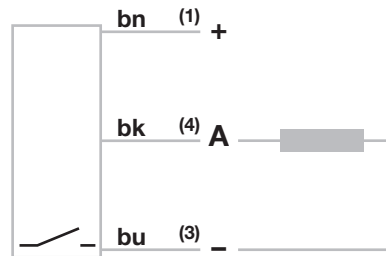

Schema 2 *diagramm 2*

PNP Öffner (NC)
PNP opener (NC)

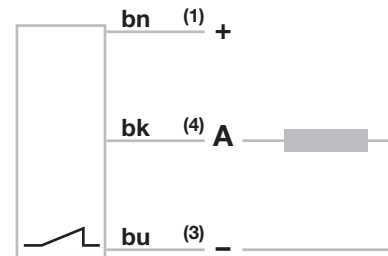

Schema 3 *diagramm 3*

PNP Schließer/Öffner (NO/NC)
PNP closer/opener (NO/NC)

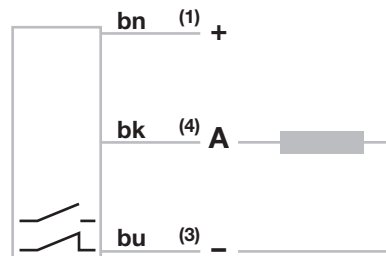

Schema 4 *diagramm 4*

NPN Schließer (NO)
NPN closer (NO)

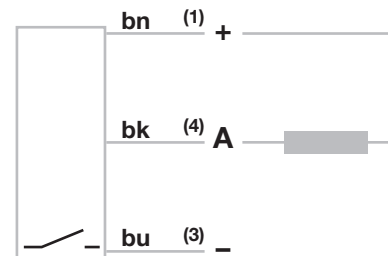

Schema 5 *diagramm 5*

NPN Öffner (NC)
NPN opener (NC)

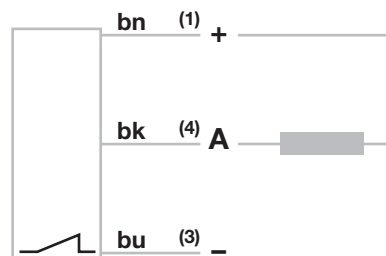

Schema 6 *diagramm 6*

NPN Schließer/Öffner (NO/NC)
NPN closer/opener (NO/NC)

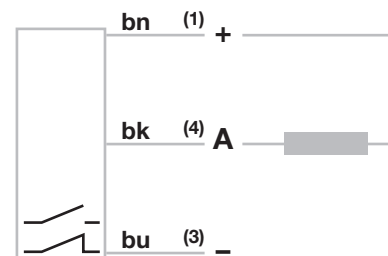

Schema 8 *diagramm 8*